

Universal relay card

If you want to switch large electric currents using an electronic control and require control isolation at the same time, then this card is a valuable asset.

Total solder points: 351

Difficulty level: *beginner* 1 2 3 4 5 *advanced*

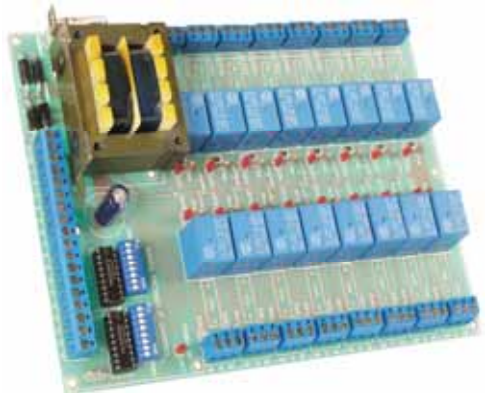
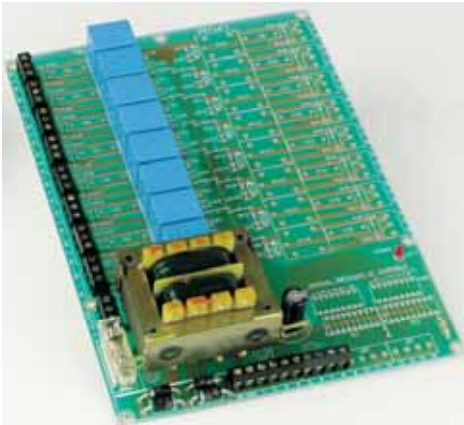

K6714

K6714-16

Features :

- ☑ The relays can be controlled in different ways : direct control from open-collector outputs, TTL or CMOS level or trough other kits (K6711, K8000, K8023,...)
- ☑ Every output of the print can be equipped with a noise suppressor network.
- ☑ Output 12V CC can be used as a power supply for other kits: K6711, K8023,...

Specifications

- Power supply: 230 or 125VAC max. 12VA.
- Output voltage: 12V/250mA.
- Relay switch-over contact: max. 5A at 220V.
- PCB dimensions: 150 x 212mm (5.9" x 8.4")

1. Assembly (Skipping this can lead to troubles !)

Ok, so we have your attention. These hints will help you to make this project successful. Read them carefully.

1.1 Make sure you have the right tools:

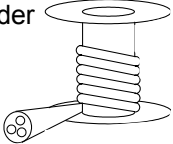
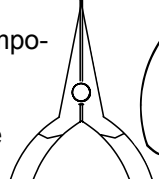
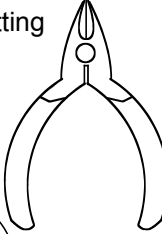
- A good quality soldering iron (25-40W) with a small tip. 
- Wipe it often on a wet sponge or cloth, to keep it clean; then apply solder to the tip, to give it a wet look. This is called 'thinning' and will protect the tip, and enables you to make good connections. When solder rolls off the tip, it needs cleaning.
- Thin raisin-core solder. Do not use any flux or grease. 
- A diagonal cutter to trim excess wires. To avoid injury when cutting excess leads, hold the lead so they cannot fly towards the eyes.
- Needle nose pliers, for bending leads, or to hold components in place. 
- Small blade and Phillips screwdrivers. A basic range is fine. 

 **For some projects, a basic multi-meter is required, or might be handy**

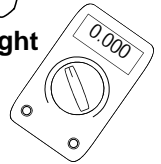

1.2 Assembly Hints :

- ⇒ Make sure the skill level matches your experience, to avoid disappointments.
- ⇒ Follow the instructions carefully. Read and understand the entire step before you perform each operation.
- ⇒ Perform the assembly in the correct order as stated in this manual
- ⇒ Position all parts on the PCB (Printed Circuit Board) as shown on the drawings.
- ⇒ Values on the circuit diagram are subject to changes.
- ⇒ Values in this assembly guide are correct*

- ⇒ Use the check-boxes to mark your progress.
- ⇒ Please read the included information on safety and customer service

* Typographical inaccuracies excluded. Always look for possible last minute manual updates, indicated as 'NOTE' on a separate leaflet.

1.3 Soldering Hints :

1- Mount the component against the PCB surface and carefully solder the leads

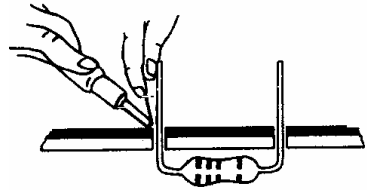

2- Make sure the solder joints are cone-shaped and shiny

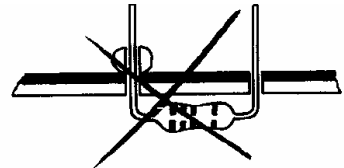
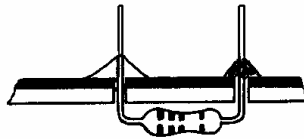

3- Trim excess leads as close as possible to the solder joint

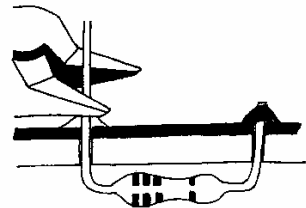

AXIAL COMPONENTS ARE TAPED IN THE CORRECT MOUNTING SEQUENCE !

REMOVE THEM FROM THE TAPE ONE AT A TIME !

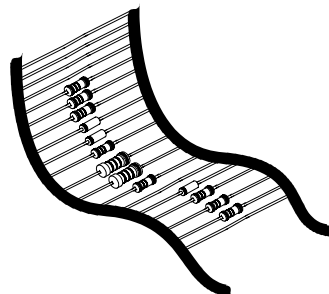

IMPORTANT

☞ To use the relay card with 16 relay outputs, mount the components marked with (*) also (K6714-16).

1. Jump wires.

☐ J

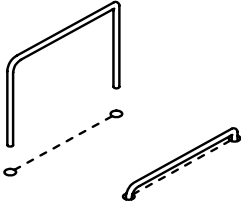

ATTENTION : In case you don't use a transistor array (IC's for K6714-16), fit the wire jumpers in the places for IC1 and IC2, marked with a dotted line.

2. Diodes (check the polarity!)

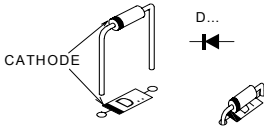

- ☐ D1 : 1N4148
- ☐ D2 : 1N4148
- ☐ D3 : 1N4148
- ☐ D4 : 1N4148
- ☐ D5 : 1N4148
- ☐ D6 : 1N4148
- ☐ D7 : 1N4148
- ☐ D8 : 1N4148
- ☐ D9 : 1N4148 (*)
- ☐ D10 : 1N4148 (*)
- ☐ D11 : 1N4148 (*)
- ☐ D12 : 1N4148 (*)
- ☐ D13 : 1N4148 (*)
- ☐ D14 : 1N4148 (*)
- ☐ D15 : 1N4148 (*)
- ☐ D16 : 1N4148 (*)

3. 1/4W Resistor.

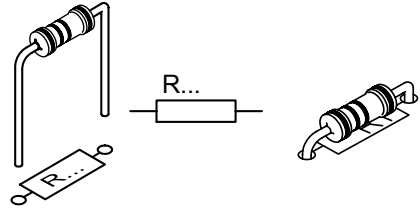

- ☐ R17 : 1K5 (1 - 5 - 2 - B)

4. Diodes (check the polarity!)

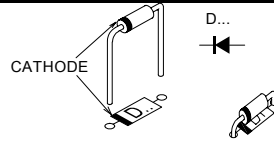

- ☐ D17 : 1N5408
- ☐ D18 : 1N5408
- ☐ D19 : 1N5408
- ☐ D20 : 1N5408

5. IC sockets. Watch the position of the notch!

- ☐ IC1 : 18P. (*)
- ☐ IC2 : 18P. (*)

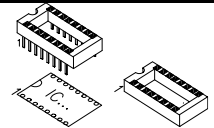

☞ **Attention : just for K6714-16 !**

6. Dip Switch. Watch the orientation!

- ☐ SW1 : Dip-8 (*)
- ☐ SW2 : Dip-8 (*)

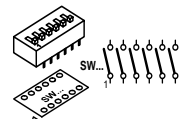

☞ **Attention : just for K6714-16 !**

7. 1/4W Resistors.

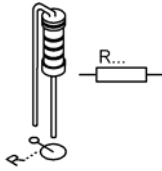

- R1 : 1K5 (1 - 5 - 2 - B) (*)
- R2 : 1K5 (1 - 5 - 2 - B) (*)
- R3 : 1K5 (1 - 5 - 2 - B) (*)
- R4 : 1K5 (1 - 5 - 2 - B) (*)
- R5 : 1K5 (1 - 5 - 2 - B) (*)
- R6 : 1K5 (1 - 5 - 2 - B) (*)
- R7 : 1K5 (1 - 5 - 2 - B) (*)
- R8 : 1K5 (1 - 5 - 2 - B) (*)
- R9 : 1K5 (1 - 5 - 2 - B) (*)
- R10 : 1K5 (1 - 5 - 2 - B) (*)
- R11 : 1K5 (1 - 5 - 2 - B) (*)
- R12 : 1K5 (1 - 5 - 2 - B) (*)
- R13 : 1K5 (1 - 5 - 2 - B) (*)
- R14 : 1K5 (1 - 5 - 2 - B) (*)
- R15 : 1K5 (1 - 5 - 2 - B) (*)
- R16 : 1K5 (1 - 5 - 2 - B) (*)

Attention : just for K6714-16 !

8. LEDs. Watch the polarity!

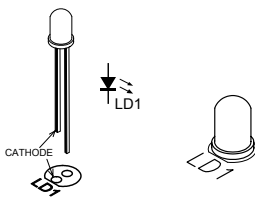

- LD1 : 3mm (*)
- LD2 : 3mm (*)
- LD3 : 3mm (*)
- LD4 : 3mm (*)
- LD5 : 3mm (*)
- LD6 : 3mm (*)
- LD7 : 3mm (*)
- LD8 : 3mm (*)
- LD9 : 3mm (*)
- LD10 : 3mm (*)
- LD11 : 3mm (*)
- LD12 : 3mm (*)
- LD13 : 3mm (*)
- LD14 : 3mm (*)
- LD15 : 3mm (*)
- LD16 : 3mm (*)
- LD17 : 3mm

9. Terminal blocks

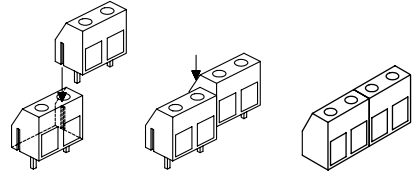

Tree-pole screw connector :

- J1
- J2
- J3
- J4
- J5
- J6
- J7
- J8
- J9 (*)
- J10 (*)
- J11 (*)
- J12 (*)
- J13 (*)
- J14 (*)
- J15 (*)
- J16 (*)
- J17

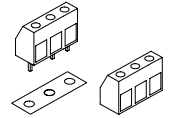

Six-pole screw connector :

- J18 (3x2p) 3 X 2P

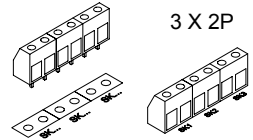

Four-pole screw connector :

- J19
- J20 (*)
- J21 (*)
- 2 X 2P

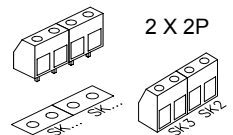

10. Fuse holder & fuse

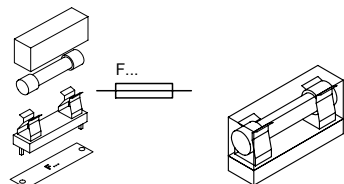

- F1 : 250mA / slow

11. Relays

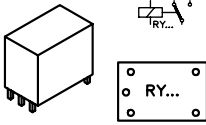

- RY1 : VR15M121C
- RY2 : VR15M121C
- RY3 : VR15M121C
- RY4 : VR15M121C
- RY5 : VR15M121C
- RY6 : VR15M121C
- RY7 : VR15M121C
- RY8 : VR15M121C

- RY9 : VR15M121C (*)
- RY10 : VR15M121C (*)
- RY11 : VR15M121C (*)
- RY12 : VR15M121C (*)
- RY13 : VR15M121C (*)
- RY14 : VR15M121C (*)
- RY15 : VR15M121C (*)
- RY16 : VR15M121C (*)

12. Electrolytic capacitor. Check the polarity !

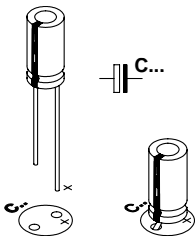

- C17 : 1000µF/25V

13. Transformer

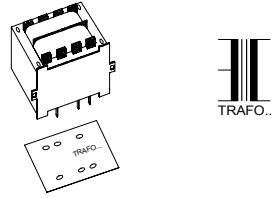

- Trafo : 12VA 2x6V - 2 x 1A

☞ **Attention** : See that the 6V or 220V connections come in the right place.

14. IC's check the position !

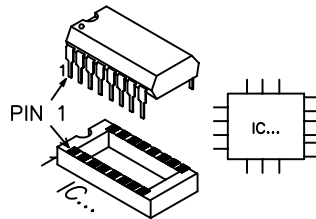

- IC1 : ULN2803 (*)
- IC2 : ULN2803 (*)

☞ **Attention** : just for K6714-16 !

15. Noise suppression of the relay contacts “OPTIONAL !” :

At the standard module K6714 as well K6714-16 have you the opportunity to noise-suppress every relay contact.

First : mount the resistors to noise-suppress the normally open contact of the relay :

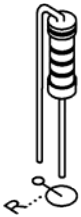

- R19, R21, R23, R25, R27, R29, R31, R33 : 220Ω/0,5W
- R34, R36, R38, R40, R42, R44, R46, R48 : 220Ω/0,5W (*)

Or mount the resistors to noise-suppress the normally closed contact of the relay :

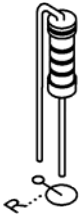

- R18, R20, R22, R24, R26, R28, R30, R32 : 220Ω/0,5W
- R35, R37, R39, R41, R43, R45, R47, R49 : 220Ω/0,5W (*)

Next mount the capacitors :

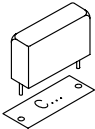

- C1...C8 : 100nF/400V - Type : .1/250A or 15MQ100.
- C9...C16 : 100nF/400V - Type : .1/250A or 15MQ100 (*)

To use the relay card with 16 relay outputs, mount the components marked with (*) also (K6714-16).

16. IMPORTANT :

If you want an electronic controller to be able to switch higher currents and at the same time you need an insulation between the controller and the controlled items, then a relay module is an indispensable help.

The module is very well suited to be connected to our kits K6711 (15 channel IR receiver) and one or two times K8023.

For those two kits power can be taken direct from the relay module. The module can also be used together with the open collector interface module K8000.

The module can of course also be used very well in other applications.

OPTIONS :

In its standard version the module contains 8 relays (K6714), but in the full version the module (K6714-16) contains :

- ✓ 16 relays.
- ✓ DIP switches for manual operation.
- ✓ An indication LED per relay.
- ✓ Two ULN2803 type transistor array (IC's).

You can fit the standard module K6714 with another 8 relays (12V types) yourself. However this requires the installation of additional screw connectors.



The ULN2803 type transistor array allows you to control the relays direct from a TTL or CMOS. For controlling the relay with open collector control, don't mount the transistors arrays.

17. TEST AND CONNECTIONS :

Connect the phase to “0” and the Neutral to “125” or “220”, depending on the mains voltage.

Normally the POWER ON LED should be lit now.

In case no manual operation has been provided, you can test the relay by connecting the inputs (terminals 1 trough 16) to earth (GND) one after another.

Connections possibility's :

1. Connect the board to the 15 channel receiver K6711 (see Fig. 1.0)

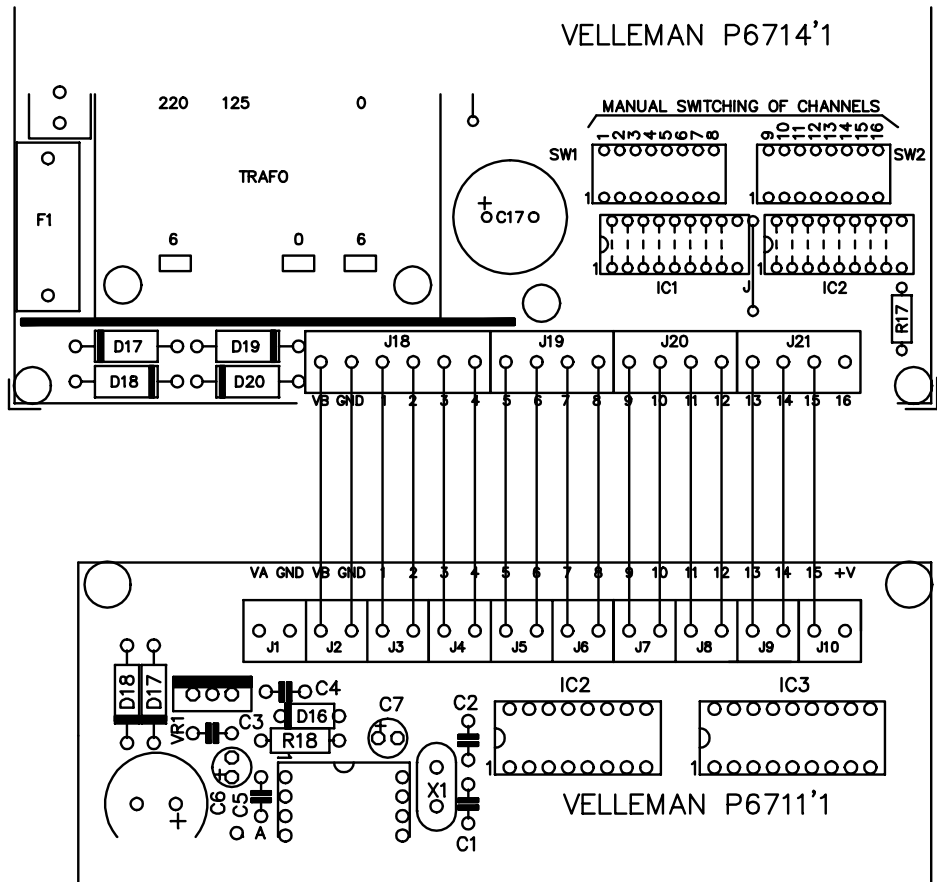

2. Connect the board to the 10 channel, 2 wire remote control K8023 (see Fig. 2.0) :

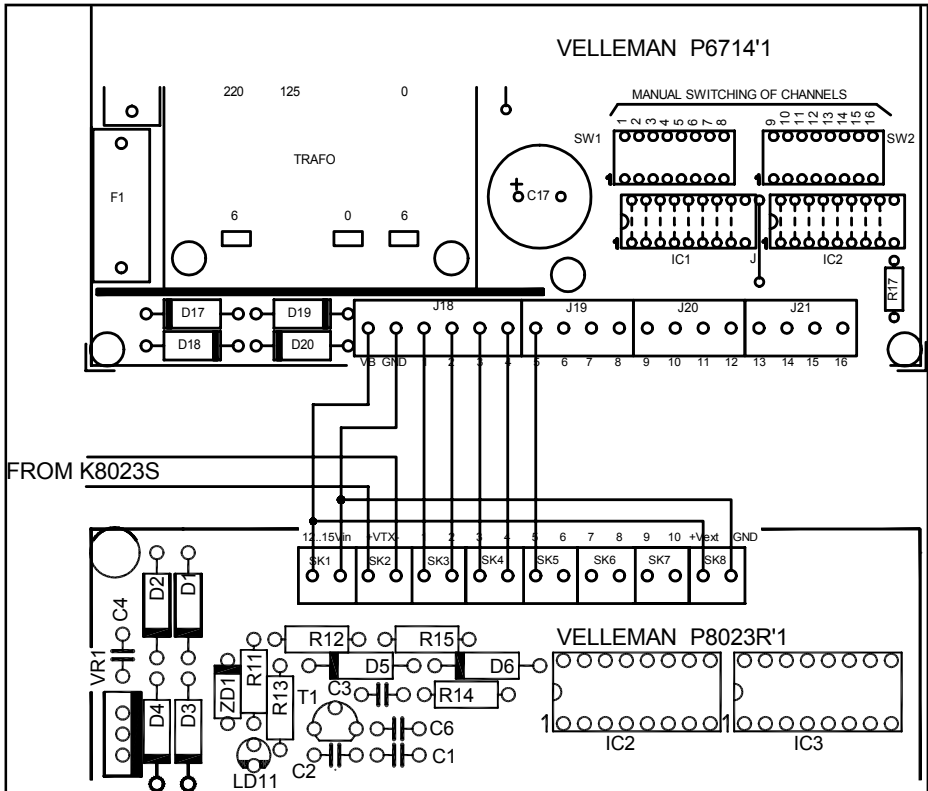

FIG 2.0

18. Remedies in the case of malfunction caused by the relays

If the relays are used to switch alternating voltage, it may be necessary to suppress them.

1. Suppressing resistive loads (Lamp, resistor,...) :

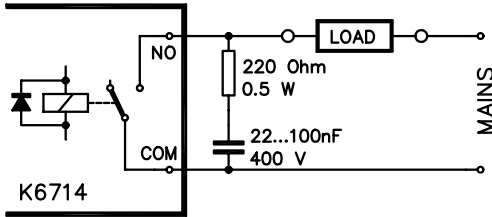

Fig. 3.1

2. Suppressing inductive loads (Transformer, motor,...) :

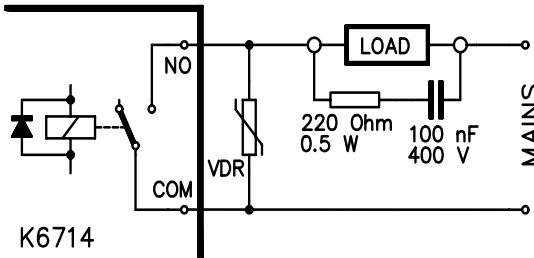

Fig. 3.2

3. When above solutions fail :

In this last case an independently fed DC-relay is used, which is installed as close to the load as possible.



Pay attention to the diode which is fit ANTI-parallel with the coil, its cathode connected to the plus side, its anode connected to the minus side! This relay **MUST** be fed by a separate power supply. The VDR must be suited for the voltage to be switched.

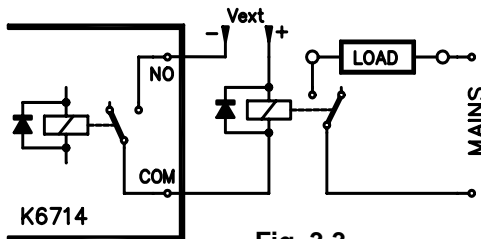

Fig. 3.3

220V - 240V

Siemens SIOV
S14K275

110V - 125V

Siemens SIOV
S14K150

19. INFORMATION FOR UPGRADING YOUR MODULE !

Components necessary to upgrade the K6714 to K6714-16 “16 Relay outputs” :

Component	Quantity	Description	Order Nr.
Diodes	8	1N41418 small signal diode.	1N4148
Resistors	16	1/4W—1K5	
LED's	16	3mm Rd 1.0 MCD TD universal	LED3RL
IC Socket	2	18P DIL IC Socket 300 Mil.	18P
DIP switch	2	DS-8 DIP switch 1P and 8Pos.	DS-8
Terminal blocks	6	Screw connector print 2 pole Blue	Screw02
Terminal blocks	8	Screw connector print 3 pole Blue	Screw03
Relays	8	Miniature Rel 12V/15A/1C JZC-22F 1Z	Vr15M121 C
IC's	2	Octal high Current/High Voltage Driver	ULN2803

OPTION : Noise suppression of the relay contacts :

Component	Quantity	Description	Order Nr.
Resistors	8*	0,5W / 220 Ohm	RB220E0
Capacitors	8*	100nF / 400V	15MQ100 or 1/250A



The quantity shown only pertains to the K6714 with an 8-relay output. Double the quantity if you wish to extend your standard module to a 16-relay output.



(*) Simply double the quantity if you have the K6714-16 kit.

20. PCB

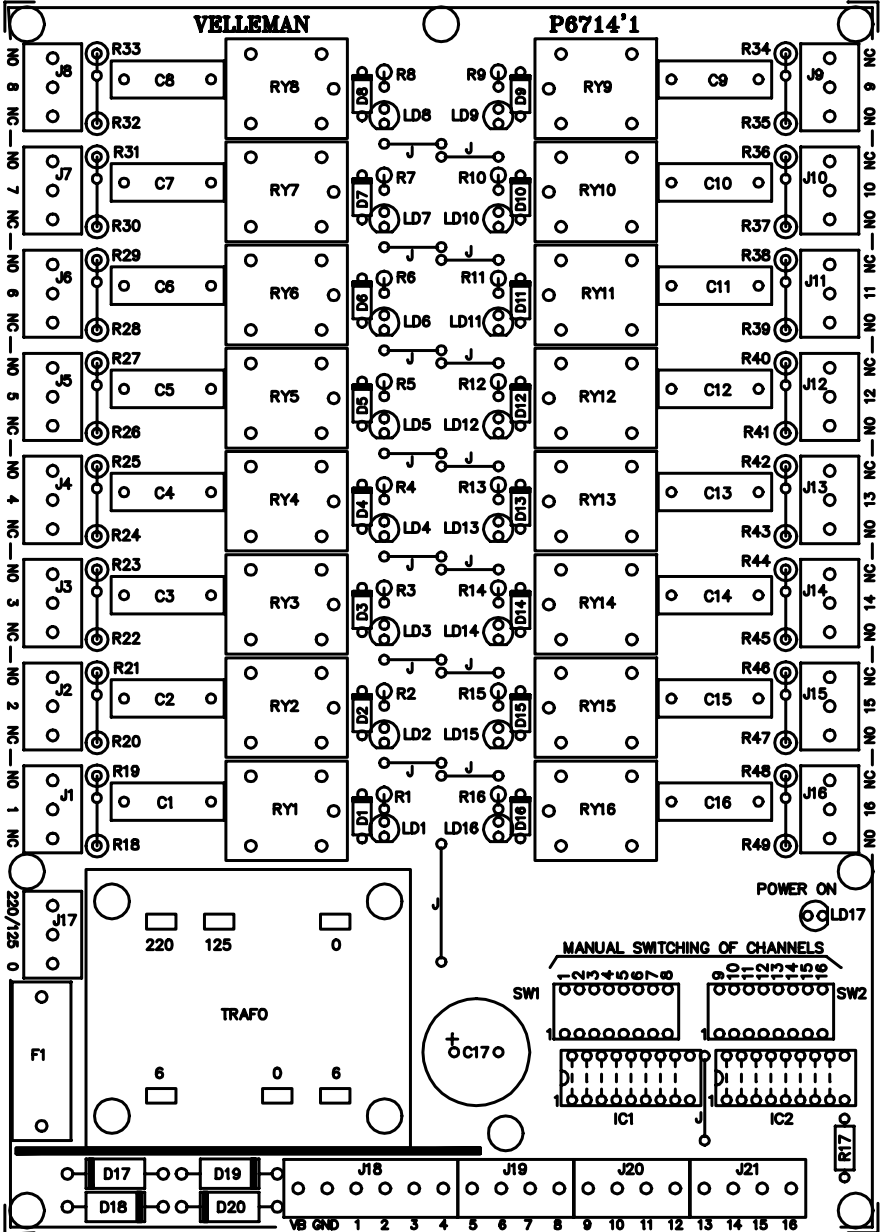

21. Digital selection

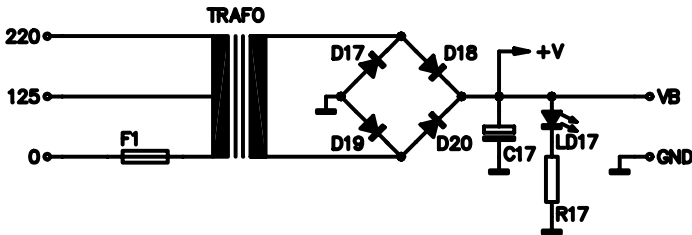
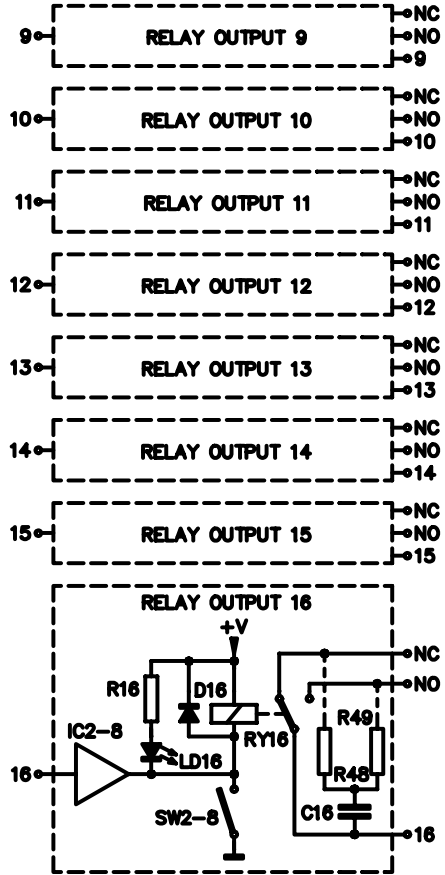
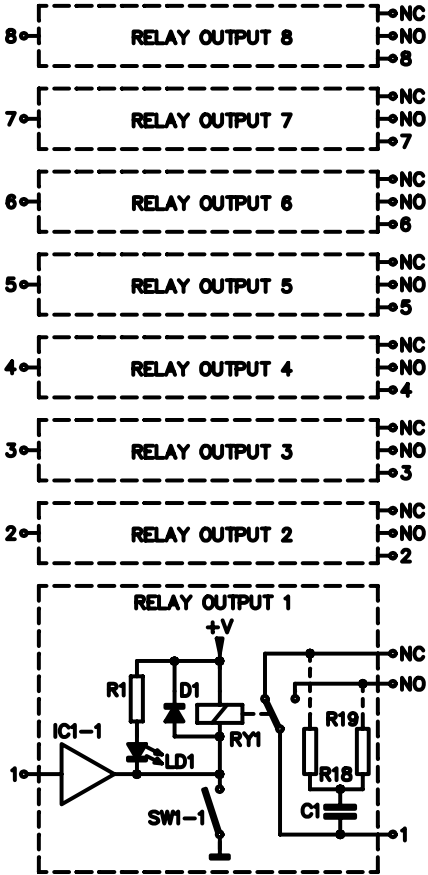



VELLEMAN KIT NV
Legen Heirweg 33
9890 Gavere
Belgium Europe
Info ? : <http://www.velleman.be>

Modifications and typographical errors reserved
© Velleman Kit nv
H6714(16)IP - 2004 - ED1

